

THE STORM ARMOR BLOODDRAGON, THE NUMBER ONE EVOLUTIONARY OF THE E-SPORTS CHAIR, THE BRAND
GLIDES THE PLAYER'S NATURE AND EVOLVES TOGETHER WITH THE PLAYER, COMMITTED TO BECOMING THE
PIONEER BELIEF OF A NEW GENERATION OF PLAYERS. ●●

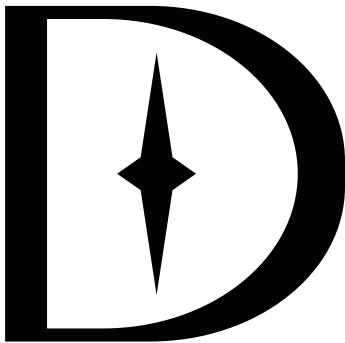

BLOODDRAGON



PRODUCT MANUAL

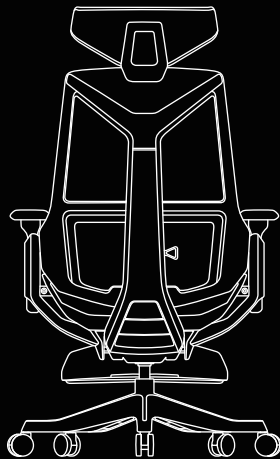









BLOODDRAGON







E-SPORTS
CHAIRS
EVOLUTION



Product Installation Instructions

Parts list





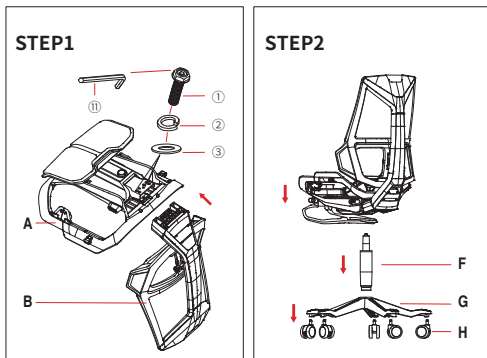

A  saddle×1	B  backrest×1	C  armrest×1
D  headrest×1	E  headrest cover×1	F  cylinder×1
G  chair foot×1	H  pulley×5	

7 	M6*20mm×2PCS	8 	M6*20mm×2PCS
9 	ST4*16mm×2PCS	10 	4mm×1PCS
11 	5mm×1PCS	12 	5*35mm×1PCS

Installation steps



List of Screws

1 	M8*25mm×3PCS	2 	M8*13mm×3PCS
3 	M8*20mm×3PCS	4 	M6*25mm×2PCS
5 	M6*10mm×2PCS	6 	M6*16mm×2PCS

STEP3

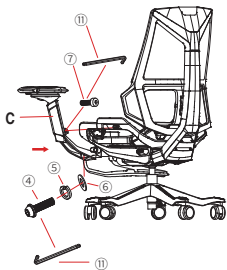

STEP4

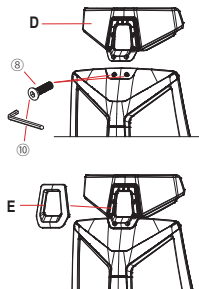

STEP5

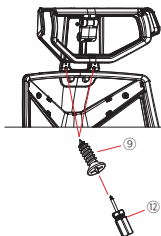

STEP6

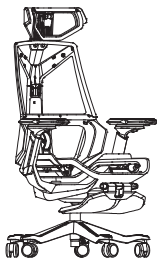

The right chair for you

BLS office chairs come with a 5-year warranty that includes parts and labor for casters, pneumatic bars, tilt mechanisms, and all mobility mechanisms, please contact the merchant for warranty limitations on materials.

Feel better, work better

The BLS range is based on ergonomic research and is designed to help people feel good and therefore work better, well at work.

Maintenance methods and precautions:

- During the assembly process, please confirm all the screws, all must be locked, to ensure that the back pad is completely fixed.
- Do not sit on the chair when the chair screws are loose. Check the screws at least every six months for looseness to ensure safe use.
- This product is limited to one person at a time.
- Do not use the chair as a climbing ladder.
- If the component of the product is lost, broken or damaged, immediately deactivate the product until it is repaired with the manufacturer's specified components.
- Please strictly follow the above precautions to avoid unnecessary harm.

Seat height: Right side outer pull buckle



Elevated:



Lift the pull tab up, stand up slightly, adjust to the appropriate height and release the pull tab to lock.



Diminish:

Sitting and utilizing your own weight, similarly lift the pull tab upwards to achieve a downward effect, and release the pull tab to lock it in place. It can be locked by releasing it.



At the proper height, your feet should be flat on the floor.

Seat backrest tilt lock: Left-hand side buckle



4-speed lockout:



When seated, lift the pull tab upward to unlock it and adjust the tilt angle in 4 positions, then lift it upward to lock the tilt angle.



Seat plate forward and backward movement: Right side inner pull buckle



Slide back and forth:

A person can unlock it by sitting on it and lifting the pull tab upward for forward and backward sliding adjustments, and it can be locked by releasing the pull tab.



Armrest angle/height: Armrest cushion front



Rotate right or left:



Grasp the front of the armrest pad and turn it to the left or right.

Elevated:



The height of the armrests can also be adjusted up and down by pressing the button under the armrest pad.



Adjusting the angle of the arms helps to support different types of work and postural transitions, swinging the chair arms inward for support when using the keyboard and outward to support the use of the computer mouse.

Armrest depth/width: Armrest cushion front

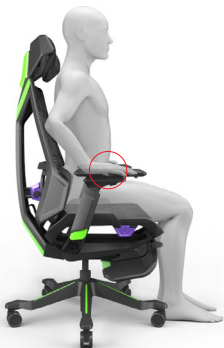

Front and rear mobile armrest cushions:

Grasp the armrest pads and slide them forward or backward.



Inside and outside pan handrail pads:

Grasp the armrest pads and pan inward or outward.



Armrest folding/tilting angle: Armrest cushion front



40° 3-position folding:

There is a pull button under the front of the armrest pad, pull out the pull button, the front of the armrest can be adjusted upward 40° 3 folding angle, adjusted to loosen the pull button can be locked.



Synchronized tilt handrail:

Synchronized tilt to follow the back



Lumbar Adjustment: Right knob behind the lumbar support



Dynamic Waist Chase Switch:

The lumbar support comes with a dynamic waist chasing function, which can adaptively stretch back and forth and rotate up and down. If you don't need this function, there is a knob on the right side of the back of the lumbar support, you can use your waist to push the lumbar support to the bottom, and then twist the knob outward to turn off the lumbar support mode, and twist it in the opposite direction to restart the dynamic lumbar support mode.

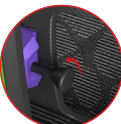

Back support: Adaptive back adjustment



Twist and chase your back for an easy fit:

The back frame is built with a rocking structure + super tough material to follow the back and swing at will.

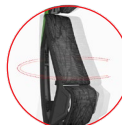

**Headrest height:
Manual adjustment**



**Headrest shell height
adjustment:**

The height of the headrest can be raised and lowered by following the headrest bracket track, dynamic lumbar support mode.



**Height adjustment within
the headrest:**

The height of the headrest can be raised and lowered by following the bracket track inside the headrest shell.



**Foot adjustment:
Cushion front**



Retractable footrest:

The pedals can be opened or retracted by pulling the pedals out and pulling the pedal shaft outward with both hands at the same time.



**Headrest angle:
Manual adjustment**



**Dual-axis flip within the
headrest:**

Dual-axis flip, precise fit linkage adjustment, release cervical spine pressure.



